

# ET01 C02

## Articulating Monitor Arm

Fits Most 13"-32" Monitors

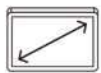
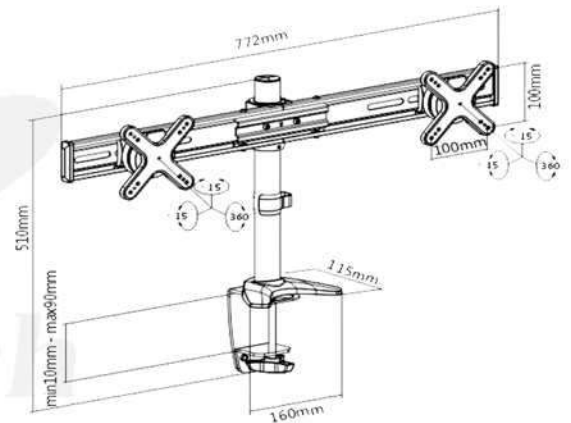

Screen Size  
13"-32"



Weight Capacity  
8kg/17.6lbs

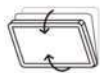

Tilt Range  
+90° ~ -40°

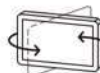

Swivel Range  
+90° ~ -90°



Screen Rotation  
360°

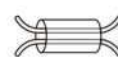

Cable  
Management

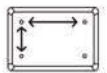

VESA Compatible  
75x75 100x100



**Portrait and Landscape Orientation.**



**Clamp & Grommet Mounts Included**  
mounts to most any style desktop.

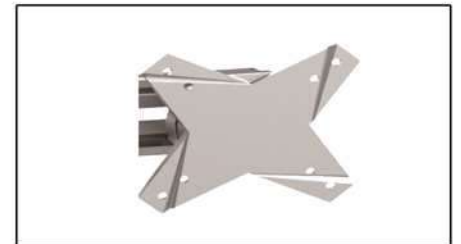

**Detachable VESA Plate**  
enables easy installation.